

NOTES:

- 3" 12ga Galvanized Jamb (standard)
- 1-3/4" 14ga Galvanized Gate (standard)
- Rockwood Pull Handle (x2)
- Von Duprin 99 Series Exit Device with Quiet Electric Latch Retraction
- Torxun Autoped Model 10 Operator (x1)
- LCN 4040XPSRI Parallel Arm Closer (x1)
- Terminal Box with connections to Operator (see installation instructions for wiring layout)
- Sargent L980A Lockable Mullion (standard)
- Heavy Duty McKinney Hinge (x6) (standard)
- 1" Picket with X-Span Infill (other infill options available)

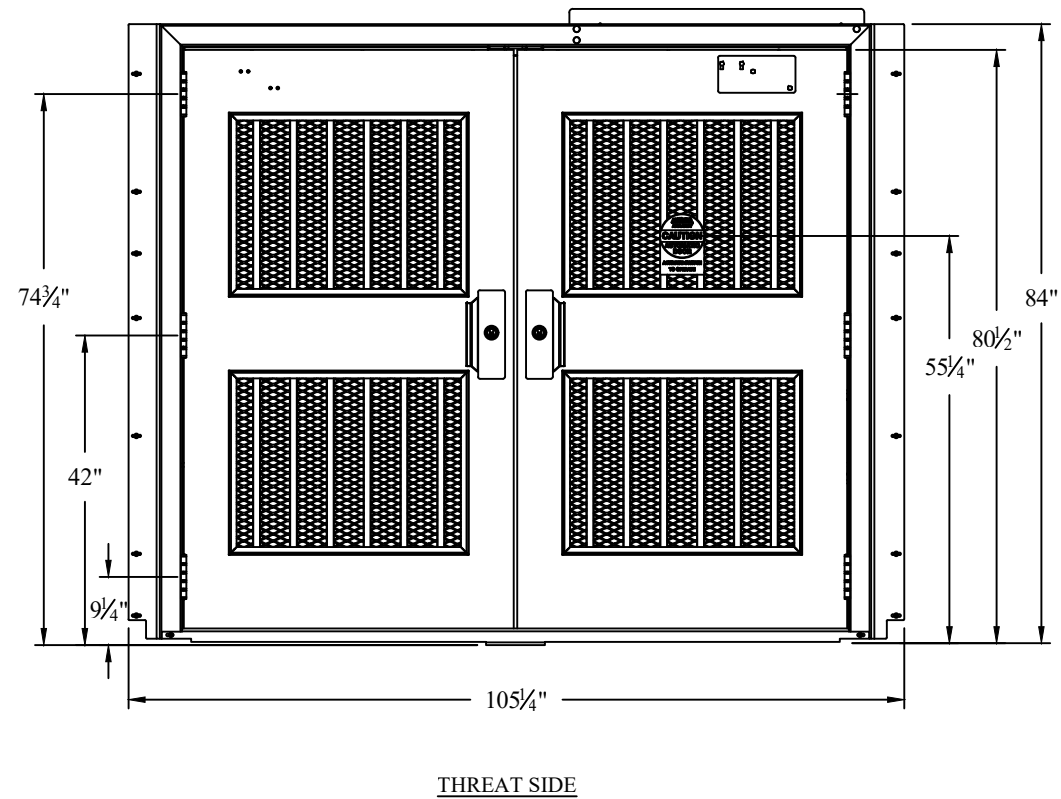
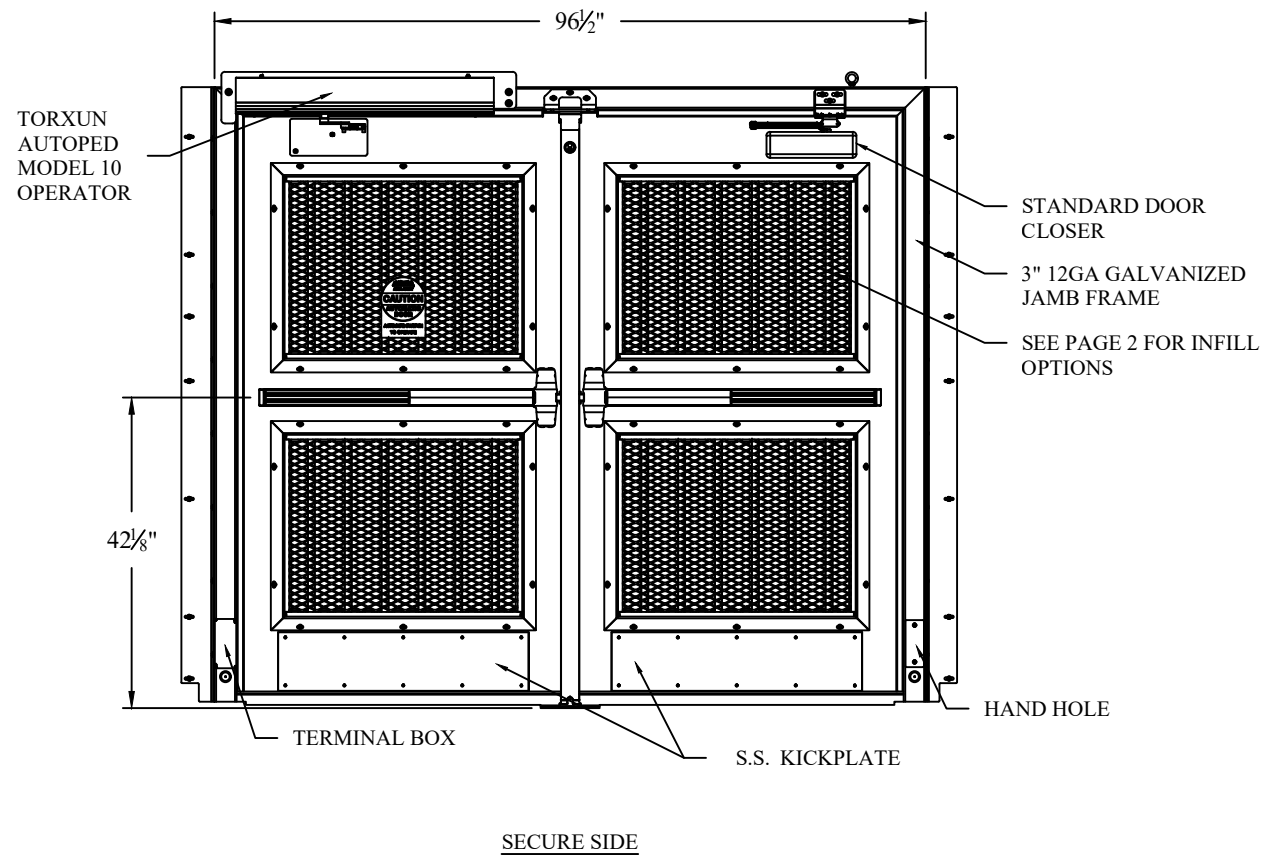
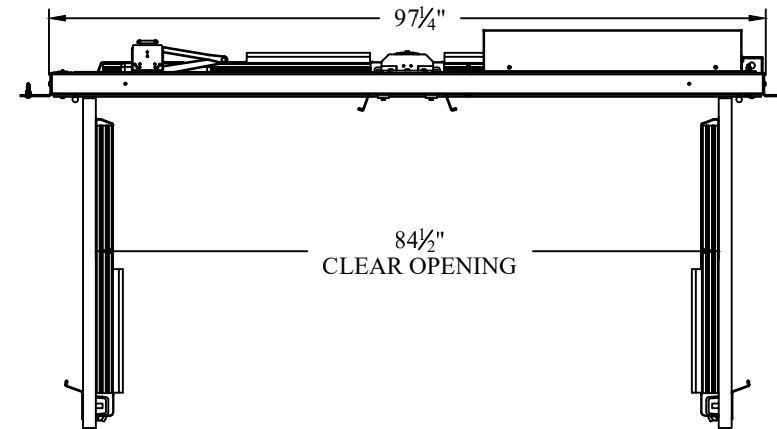

**HARDWARE OPTIONS:**

SET 3EL-1AG

DETEX V40 EXIT DEVICE W/REQUEST TO EXIT SWITCH  
 ROCKWOOD VRT16 PULL HANDLE  
 TORXUN AUTOPED MODEL 10 OPERATOR (x1)  
 NORTON 7500 PARALLEL ARM CLOSER (x 1)  
 ELECTRIC LATCH RETRACTION

SET 4EL-1AG

VON DUPRIN 99 SERIES EXIT DEVICE  
 ROCKWOOD VER16 PULL HANDLE  
 TORXUN AUTOPED MODEL 10 OPERATOR(x1)  
 LCN 4040 XPSRI PARALLEL ARM CLOSER (x 1)  
 QUIET ELECTRIC LATCH RETRACTION

SET 4CEL-1AG

CBC VON DUPRIN 99 SERIES EXIT DEVICE  
 ROCKWOOD VER16 PULL HANDLE  
 TORXUN AUTOPED MODEL 10 OPERATOR(x1)  
 LCN 4040 XPSRI PARALLEL ARM CLOSER (x 1)  
 QUIET ELECTRIC LATCH RETRACTION

DETEX A40 (3AMP REQUEST TO EXIT SWITCH)

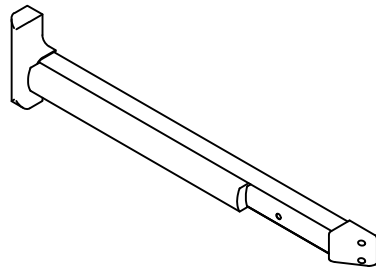

VON DUPRIN 99 SERIES DEVICE W.QUIET ELECTRIC LATCH RETRACTION

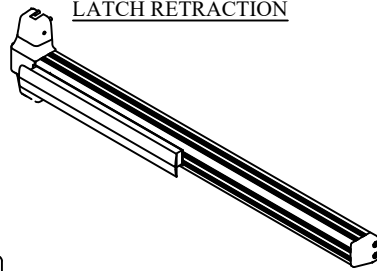

ROCKWOOD PULL HANDLE

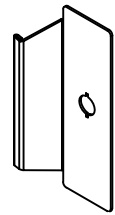

LCN 4040XPSRI PARALLEL ARM CLOSER

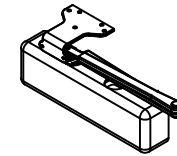

NORTON 7500 PARALLEL ARM CLOSER

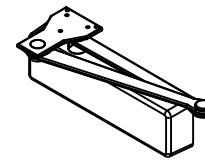

TORXUN AUTOPED MODEL 10 OPERATOR

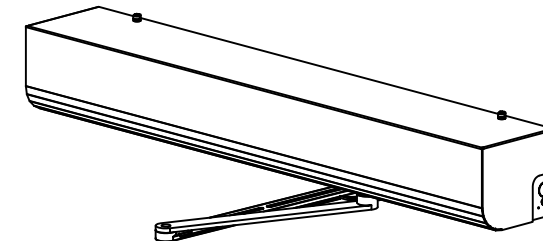

INFILL OPTIONS:

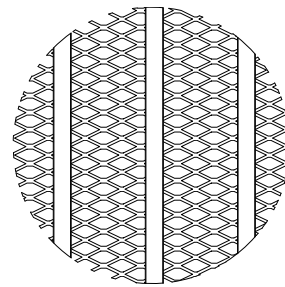

1" PICKET W/ $\frac{3}{4}$ " #9 FLAT EXPANDED METAL

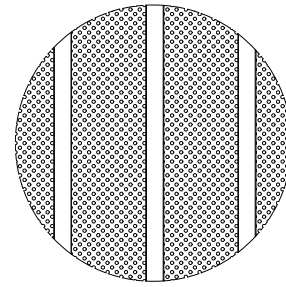

1" PICKET W/ $\frac{3}{16}$ " RND X  $\frac{1}{2}$ " 18GA PERF

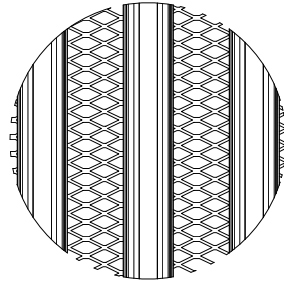

PALE W/ $\frac{3}{4}$ " #9 FLAT EXPANDED METAL

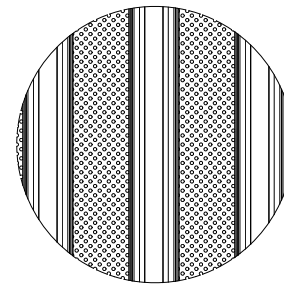

PALE W/ $\frac{3}{16}$ " RND X  $\frac{1}{2}$ " 18GA PERF

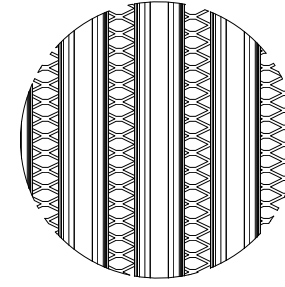

ANTI-CLIMB PALE W/ $\frac{3}{4}$ " #9 FLAT EXPANDED METAL

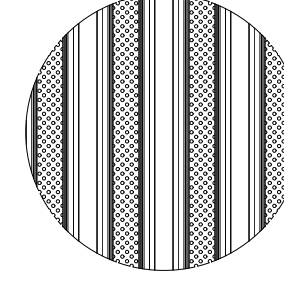

ANTI-CLIMB PALE W/ $\frac{3}{16}$ " RND X  $\frac{1}{2}$ " 18GA PERF

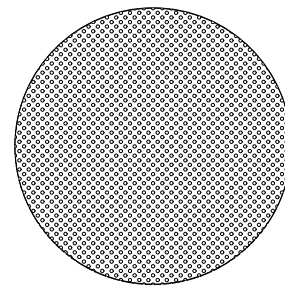

$\frac{3}{16}$ " RND X  $\frac{1}{2}$ " 18GA PERF

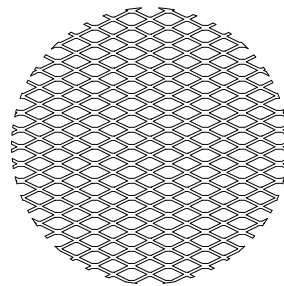

X-SPAN® .75" X #9F

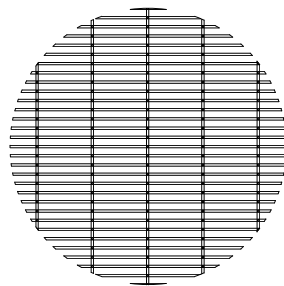

WIREWOKS ANTI-CLIMB® 3" X .5" X 10.5GA

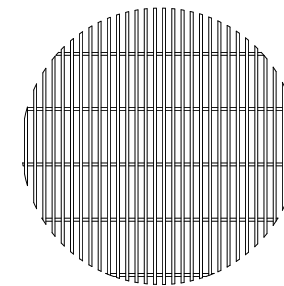

WIREWOKS® .5" X 3" X 8GA & 6GA

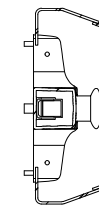

EXIT DEVICE GUARD  
P/N: PHEG42

